

3		2		1	
Version	Reasons for change		DATE	Design	

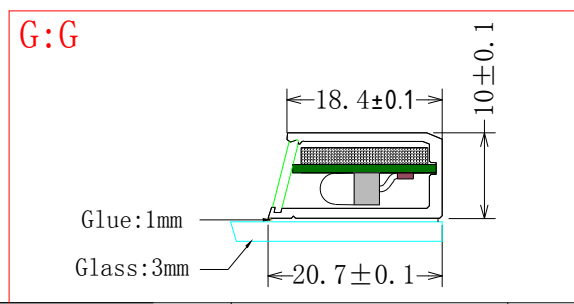
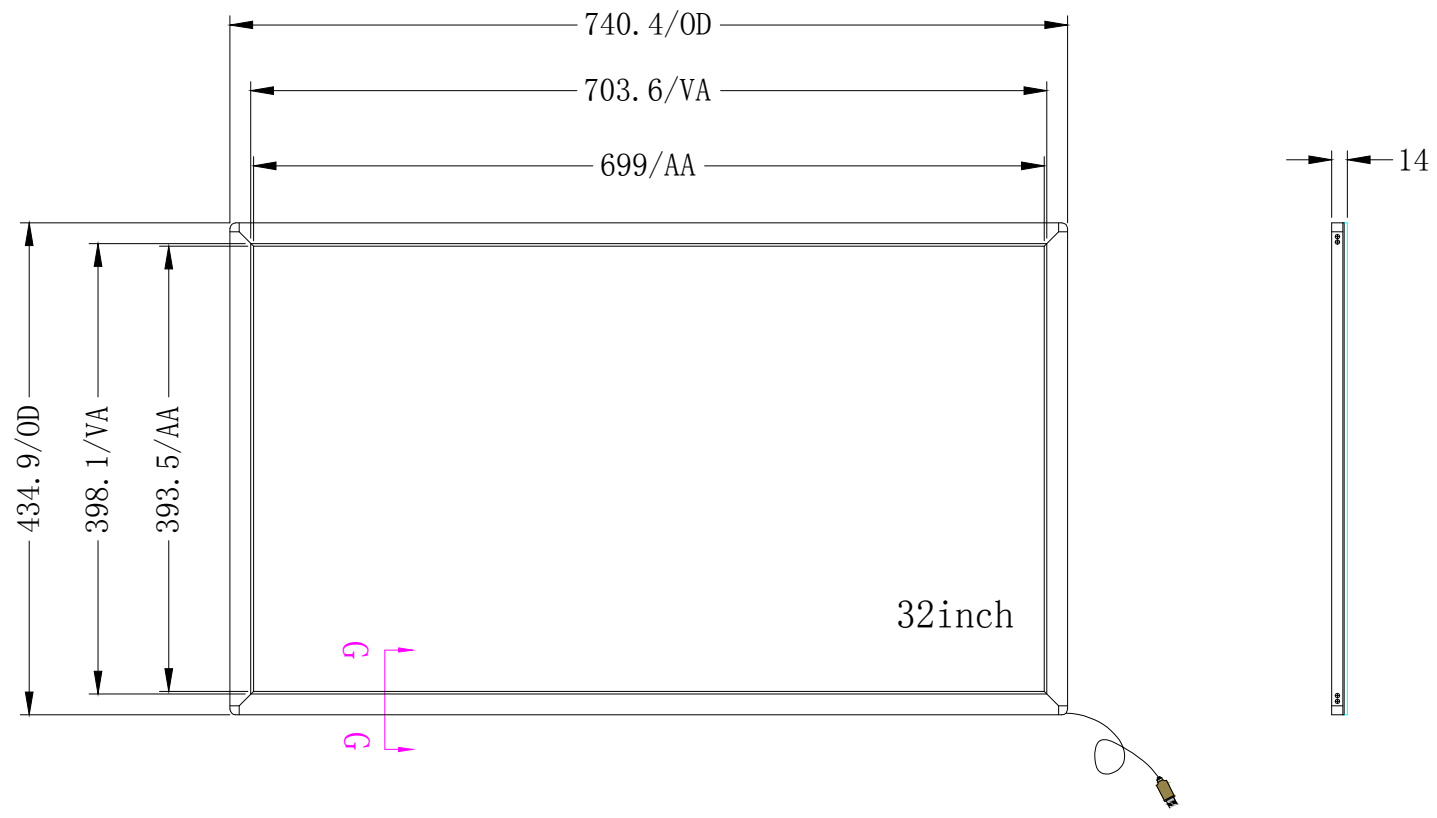

TOLERANCES (UNLESS OTHERWISE STATED)	
DECIMALS	ANGLES ±0.5°
>2000mm	±2.00mm
1600 < X ≤ 2000mm	±1.20mm
1200 < X ≤ 1600mm	±0.80mm
800 < X ≤ 1200mm	±0.50mm
400 < X ≤ 800mm	±0.30mm
120 < X ≤ 400mm	±0.20mm
30 < X ≤ 120mm	±0.20mm
≤ 30mm	±0.15mm

THIRD ANGLE PROJECTION

GreenTouch Technology Co.,Ltd			
Model No:	GT-IR-TB32-1	Size:	32"
Ratio:	16:9	Unit:	mm
Design:	MR. LI	DATE:	2018.12.06
Scale:	1:1	Version:	A1
Page:	1/1		