

Version	Reasons for change	DATE	Design

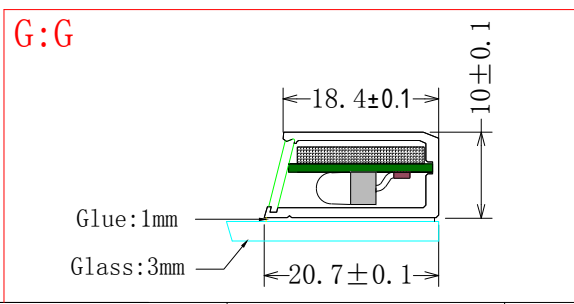
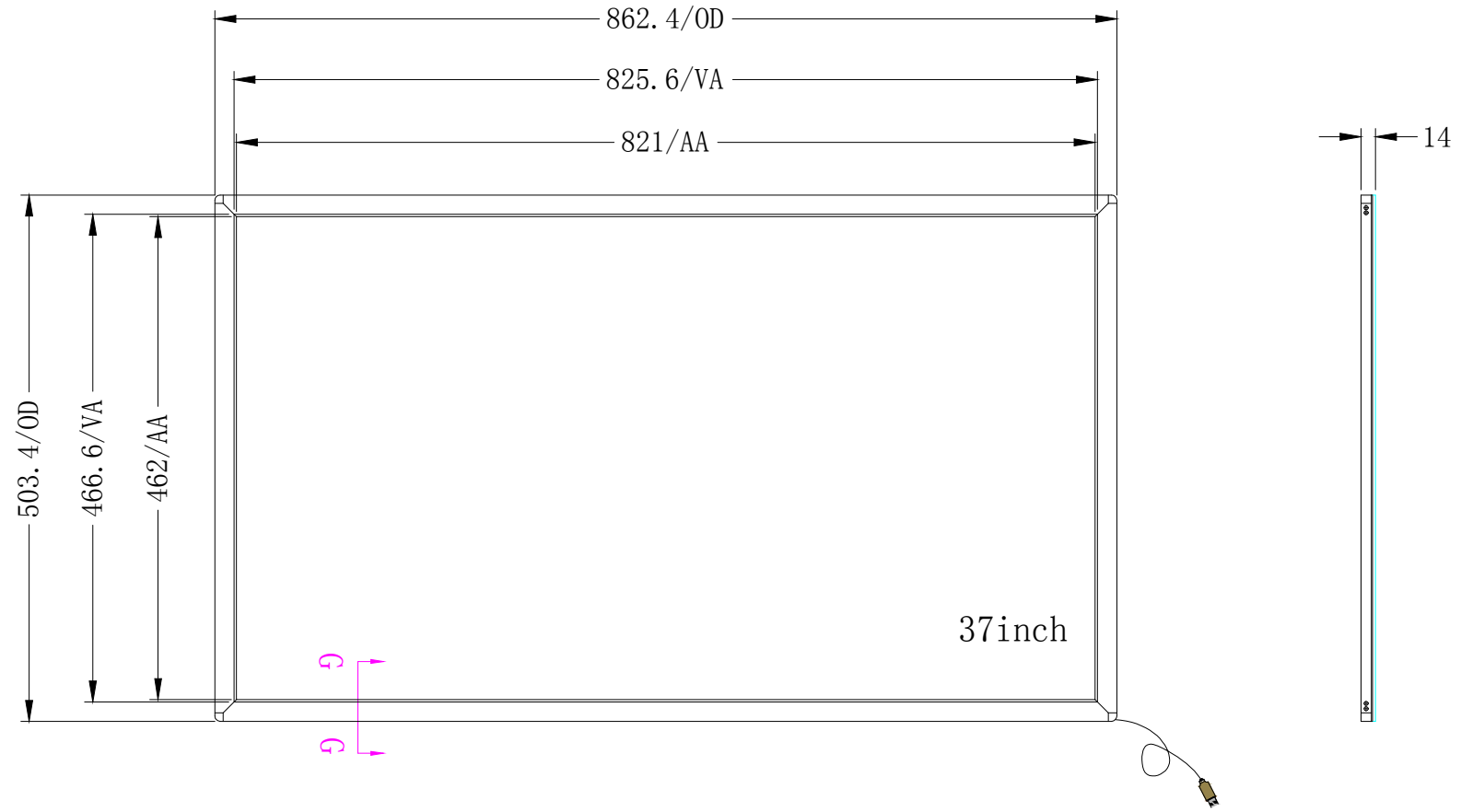

TOLERANCES
(UNLESS OTHERWISE STATED)

DECIMALS	ANGLES	±0.5°
>2000mm	±2.00mm	
1600 < X ≤ 2000mm	±1.20mm	
1200 < X ≤ 1600mm	±0.80mm	
800 < X ≤ 1200mm	±0.50mm	
400 < X ≤ 800mm	±0.30mm	
120 < X ≤ 400mm	±0.20mm	
30 < X ≤ 120mm	±0.20mm	
≤ 30mm	±0.15mm	

THIRD ANGLE PROJECTION

格林触控
GreenTouch GreenTouch Technology Co.,Ltd

Model No:	GT-IR-TB37-1	Size:	37"
Ratio:	16:9	Unit:	mm
Design:	MR. LI	DATE:	2018.12.06
Scale:	1:1	Version:	A1
Page:	1/1		